

Loughborough University
Institutional Repository

*Single-vehicle collisions in
Europe: analysis using
real-world and crash-test
data*

This item was submitted to Loughborough University's Institutional Repository by the/an author.

Citation: NAING, C.L. ... et al, 2008. Single-vehicle collisions in Europe: analysis using real-world and crash-test data. *International Journal of Crashworthiness*, 13 (2), pp.219-229.

Additional Information:

- This article was accepted for publication in the *International Journal of Crashworthiness* [© Taylor & Francis] and the definitive version can be found at: <http://dx.doi.org/10.1080/13588260701788583>

Metadata Record: <https://dspace.lboro.ac.uk/2134/5457>

Version: Accepted for publication

Publisher: © Taylor & Francis

Please cite the published version.

This item was submitted to Loughborough's Institutional Repository (<https://dspace.lboro.ac.uk/>) by the author and is made available under the following Creative Commons Licence conditions.



CC creative commons
COMMONS DEED

Attribution-NonCommercial-NoDerivs 2.5

You are free:

- to copy, distribute, display, and perform the work

Under the following conditions:

 **Attribution.** You must attribute the work in the manner specified by the author or licensor.

 **Noncommercial.** You may not use this work for commercial purposes.

 **No Derivative Works.** You may not alter, transform, or build upon this work.

- For any reuse or distribution, you must make clear to others the license terms of this work.
- Any of these conditions can be waived if you get permission from the copyright holder.

Your fair use and other rights are in no way affected by the above.

This is a human-readable summary of the [Legal Code \(the full license\)](#).

[Disclaimer](#) 

For the full text of this licence, please go to:
<http://creativecommons.org/licenses/by-nc-nd/2.5/>

Single Vehicle Collisions in Europe: Analysis Using Real World and Crash Test Data.

C L Naing ^a, J Hill ^a, R Thomson ^b, H Fagerlind ^b, M Kelkka ^c, C Klootwijk ^d,
G Dupre ^e and O Bisson ^e

Vehicle Safety Research Centre, Loughborough University, UK ^a
Chalmers University of Technology, Gothenburg, Sweden ^b
Helsinki University of Technology, Helsinki, Finland ^c
TNO Automotive, The Netherlands ^d
CETE, France ^e

ABSTRACT

A large proportion of European road casualties result when a vehicle leaves the main carriageway, often impacting roadside obstacles. As part of the EC-funded project, RISER (Roadside Infrastructure for Safer European Roads), a number of activities were undertaken to collate the type of data which is needed to understand the frequency and severity of real world crash situations and relate this to crash test data mandated in the EU. Accident data was collected and used to create a statistical database and a detailed database exclusively for single vehicle 'run-off the road' collisions on major rural (not urban) roads, simulation software was used to further understand impacts with roadside structures and an inventory of crash test data was collected for impacts with objects such as poles and safety barriers^a.

The combination of real world accident data, simulations and crash test data has provided a unique insight into the characteristics of single vehicle collisions, helping us to understand them better and make recommendations for consideration when drafting design guidelines. This information is crucial for those involved in the design and evaluation of the roadside environment.

NOTATIONS

V	Impact speed
B	Impact angle
Φ	Vehicle orientation
km/h	Kilometres per hour

INTRODUCTION

Single vehicle accidents^b are a unique type of accident which, up to now, have not been comprehensively investigated in any way representative of the European situation. However, from the published literature, it can be seen that single vehicle accidents do indeed make up a significant proportion of the seriously and fatally injured on European roads. In Great Britain, the EuroRAP study [1] has shown that, on single carriageway roads, run-off road accidents involving collisions with roadside objects are one of the four main types of accidents (the other three being head-on collisions, collisions at junctions and accidents involving vulnerable road users). In Eurostat [2], it is reported that over 33% of fatalities which occur in road accidents, occur in single vehicle collisions. A high proportion of these are on high speed, rural roads, particularly roads which link major towns and cities. Therefore, there is a real need for improving the safety of the roadside across Europe.

In a single vehicle accident, the vehicle will more than likely leave the road and have a collision in the roadside. This collision could be with objects such as poles, posts, trees, walls, bridge supports or fences, or could involve contact with an embankment, slope or ditch which could lead to a rollover, or the impact could be with a safety feature such as a safety barrier or crash cushion. Studies in Europe have shown that collisions with roadside objects account for between 18% and 31% of all fatal

^a In this reports, 'safety barrier' also refers to 'guardrail'

^b Single vehicle accidents refer to all types of motor vehicles unless otherwise stated

accidents for different countries, with trees and utility poles being reported as the most frequently struck objects [3]. In Germany, impacts with obstacles account for 42% of road deaths [3]. In Great Britain, whilst other accident types have reduced over the past 15 years, rates of accidents involving impacts with roadside objects have stayed constant [4].

Outside of Europe, other studies have shown similar results, showing that the single vehicle accident problem is a worldwide issue [5, 6, 7]. For example, in the USA more than 20% of fatalities in vehicle crashes result from a vehicle leaving the road and hitting a fixed object such as a tree or pole [7].

Across Europe, there is currently no consensus on what roadside safety measures should be implemented. Therefore, in order to determine what should be taken into consideration when designing roadsides for safety, the RISER project was commissioned by the European Commission to investigate these aspects.

The RISER consortium was made up of ten partners from manufacturing, research and governmental organisations across Europe. The main aims of RISER were to:

- Create collision databases for single vehicle accident data using existing and new data sources;
- Collect technical performance data for roadside infrastructure which describes the physical interactions of vehicle and roadside and takes into account the human factors which influence the event;
- Develop best practice guidelines for roadside design and maintenance.

Project aims were successfully met, through the establishment of a rich new data resource including single vehicle accident data, crash test data and information on current design and operations guidelines. This paper aims to describe a range of data collated in RISER, providing a unique insight into the characteristics of single vehicle accidents through the use of the real world data, simulations and crash test information collected in the study. Development of best practice guidelines for roadside design and maintenance, and other outcomes from RISER will be covered in further publications.

For the purpose of RISER, a definition of the type of single vehicle accidents to be investigated was outlined, which was:

- Accidents which involve only one vehicle and no pedestrian involvement;
- All severity types, as reported in the available databases;
- All passenger vehicles, trucks and motorcycles;
- No urban or minor rural roads;
- Encroachment into and contact with the roadside or central reserve (roadside and central reserve henceforth denoted as roadside).

APPROACH

Accident data

Data collected from scenes of accidents often give the most valuable insight into the characteristics of collisions. However, before RISER, no EU or other international body had developed a database specifically to analyse single vehicle collision data in a comprehensive way. Therefore, one of the main objectives of RISER was to create two databases to accommodate this type of data, one at a statistical (descriptive) level and another at a detailed (in-depth) level.

The first task was to collate statistical data (also known as ‘macroscopic’, ‘descriptive’ or ‘police-level’ data) about single vehicle accidents from national databases from seven European countries^c, all of which were involved in the RISER project. Differences in coding strategies for each country were noted, and therefore recoding of many data variables was required. From this, a common database structure was developed, leading to a harmonised European database of single vehicle accidents and

^c Austria, Finland, France, Sweden, Spain, The Netherlands and United Kingdom.

enabling comparisons of a large amount of data at both a crash level (14 variables) and a casualty level (6 variables). The statistical database now holds approximately 264000 accidents from the years 1999-2002.

In addition, a review was undertaken of available databases holding detailed (in-depth) data in the same seven European countries. From this, a detailed database of single vehicle accidents was created using existing data. In addition to vehicle damage and occupant injury data, the RISER detailed database has the capacity to store in-depth information about the road, the roadside layout, and the struck infrastructure, plus accident causation details. 211 single vehicle accidents from the seven participating European countries were entered. However, it must be noted that due to the sampling criterion, the detailed data is not fully representative of the crash population, so statistical analysis using this detailed data was limited.

Further details about the structure of both the RISER statistical and detailed databases can be found in RISER Deliverable 1: 'Accident Databases for Collisions with Roadside Infrastructure' [8].

Reconstruction and simulation data

In addition to the data collected from the scene and vehicle, the database also holds accident reconstruction data. PC Crash^d was used to enhance the data collected from the scenes and to undertake reconstructions. PC Crash was the primary reconstruction tool used to calculate impact conditions and vehicle kinematics during the impact, and to take into account the vehicle manoeuvres prior to the impact. For RISER, the data was analysed specifically to obtain impact conditions, such as vehicle speeds and angles before, after and at the point of impact.

Simulation software such as MADYMO^e and Finite Element Analysis (notably LS-DYNA^f and PamCrash^g) were used to find out more about impacts with physical structures such as poles, trees and safety barriers and to simulate their interaction, plus the interaction of the occupants inside the vehicle. The simulation tool described here in detail is the multi body program MADYMO with ADVISER. Further details about the simulation work carried out in RISER have been reported in the deliverable 'D03: Critical Vehicle and Infrastructure Interactions' [9]. MADYMO (Mathematical Dynamic Model) is a computer program that simulates the dynamic behaviour of physical systems especially those requiring the analysis of vehicle collisions and injuries sustained by passengers. MADYMO is a combined multi-body-finite-element code. The code has a range of crash dummy models, airbags packages and belt systems, all highly realistic and validated. ADVISER is a tool that manages stochastic simulations and analysis, which provides insight in the effect of parameter variations on e.g. the injury criteria. The tool also automatically correlates numerical and experimental data and provides a corresponding objective quality rating for a numerical model.

An advantage of using this multi body approach rather than the more detailed Finite Element is the shorter calculation time. The results of the simulation work presented in this report focus on safety barrier impacts. For RISER, a specific methodology was established. First a car and a safety barrier model were built and combined in a simulation, which formed the basis for a study with stochastic simulations.

With the software package ADVISER it is possible to perform stochastic simulations. ADVISER offers three sample approaches, of which Best Latin Hypercube is the most advanced. This concept is described in the ADVISER User's Guide and Reference Guide [10, 11]. For each parameter in the numerical model, N samples can be generated according to a pre-defined distribution (uniform, Gaussian, etc.). The amount of samples is not pre-determined, but depends on the degree of certainty

^d DSD Austria, www.dsd.at

^e TNO MADYMO BV, www.madymo.com

^f Livermore Software Technology Corporation, www.lstc.com

^g ESI Group, www.esi-group.com

that is required and is independent of the number of parameters varied. Each sample set of parameter values is used to run a deterministic simulation of the model.

The parameters are varied stochastically around those used in the test (impact speed 100km/h, impact angle 20°, vehicle orientation 20°). The aim of this parameter study is to determine sensitivity of certain parameters on the impact response and to investigate whether there is a relationship between the human-based HIC (Head Injury Criterion) and the vehicle-based ASI (Acceleration Severity Index) [12]. The impact speed, impact angle and the orientation of the vehicle are varied. The specific parameters including their minimum and maximum values are shown in Table 1. In Figure 1 the vehicle and parameters are visualized. Samples of different parameter combinations are generated with the Best Latin Hypercube method, creating a random and uniform distribution that fills the whole parameter space. A total of 22 samples are generated. The trends and correlations are analyzed with linear regression analysis (LRA).

Parameters	Symbol	Unit	Min	Max
Impact speed	v	[m/s]	10	28
Impact angle	β	[°]	5	35
Vehicle orientation	φ	[°]	0	45

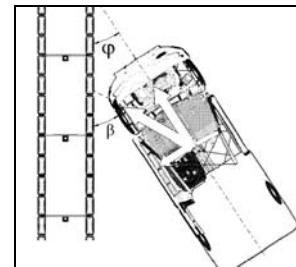

Figure 1. Definition of v , β and φ

Crash test data

A catalogue of existing crash test data was created for objects often impacted in single vehicle collisions, such as poles, crash cushions and various types of safety barriers. Due to the availability of crash test information, it was decided that analysis would be carried out on only the infrastructure groups with enough data for comparison. The only infrastructure group with extensive enough data to fulfil this requirement was safety barriers (including concrete barriers, steel barriers, and all bridge parapets).

The aim of the analysis was to investigate vehicle accelerations and occupant risk measurements (Acceleration Severity Index (ASI), Theoretical Head Impact Velocity (THIV)) for different types of barriers and their status in comparison [12].

RESULTS AND DISCUSSION

Real world data

Analysis of statistical database

In the statistical database, approximately 83% of vehicles were passenger cars or vans, while 8% were motorcycles and 8% were trucks. Less than 1% were buses. The following Table 2 shows the proportion of fatal, serious and slight injury accidents for each type of struck object recorded in the statistical database, according to injury severity categories defined for use by national police forces.

Table 2. Distribution of struck infrastructure types in RISER statistical database

RISER Single Vehicle Accidents Struck object	% of accidents			
	Fatal	Serious	Slight	Total
Tree	17%	39%	44%	100% (n = 22655)
Post	9%	31%	61%	100% (n = 8454)
Safety Barrier	6%	20%	74%	100% (n = 21466)
Ditch	8%	32%	60%	100% (n = 28192)
Other natural object	7%	32%	61%	100% (n = 1351)
Other man-made structure	11%	33%	56%	100% (n = 13978)

The data highlights that impacts with trees more often result in fatal and serious accidents (56%) than impacts with other roadside objects (26-43% of impacts). It is possible that the post impacts include a small number of impacts with energy absorbing or breakaway posts, which may have contributed to the lower proportion of fatal accidents than with trees. However, it is not possible to ascertain from the statistical database the exact specification of the infrastructure.

The scope of this paper allows only a brief introduction to this new statistical database before focusing on in-depth data and related studies below. The struck infrastructure variable was just one of many variables compiled for analysis by the RISER consortium [8].

Analysis of detailed database

Injuries recorded in the detailed database were rated using the Abbreviated Injury Scale (AIS) [13]. The injury data shows that half of the recorded injuries were AIS 2 (moderate) or above and one third were at least a serious (AIS 3) injury, with the head and thorax being the most vulnerable body regions for injury (Table 3). It should be noted that these results are made up of a mix of occupants wearing and not wearing a seatbelt.

Table 3. Injury severity data for the various body regions

AIS Body Region	\geq AIS 2	\geq AIS 3
	(Moderate or worse)	(Serious or worse)
1 Head	15.5%	12.7%
2 Face	3.5%	0.8%
3 Neck	0.9%	0.7%
4 Thorax	15.0%	12.8%
5 Abdomen	5.8%	2.4%
6 Spine	2.7%	1.7%
7 Upper Extremity	3.3%	0.7%
8 Lower Extremity	8.3%	4.8%
Total	55.1%	36.6%

Table 4 shows that when the source of the injury is investigated for the same accidents, it can be seen that, in addition to the dashboard area (10.8%), the area within the vehicle which caused the greatest number of the recorded injuries was between the A and B pillar (10.1%). Fewer injuries were caused by direct contact with a rigid roadside object while the occupant was contained within the vehicle (6.7%).

Table 4. Injury causing part of the vehicle/environment and number of injuries

Injury Causing Part		Number	Percentage	
Interior parts of vehicle	Windscreen area	26	6.3	
	Dashboard area	45	10.8	
	Centre console	12	2.9	
	Steering wheel rim	29	7.0	
	Steering wheel hub	13	3.1	
	Foot well	15	3.6	
	Roof	11	2.6	
	Side between A- and B-pillar	42	10.1	
	B-pillar	5	1.2	
	Side between B- and C-pillar	7	1.7	
	Side between C- and D-pillar	3	0.7	
	Rear parcel shelf	2	0.5	
	Seat	20	4.8	
	Seat belt system	31	7.5	
	Air bag system	10	2.4	
	Baggage or other loose object	1	0.2	
	Penetrating object into interior	17	4.1	69.5
Parts of environment	Run over	21	5.0	
	Road surface	4	1.0	
	Road kerbstone	11	2.6	8.7
Parts of environment	Post, tree (rigid roadside object)	28	6.7	6.7
Exterior part of vehicle	Windscreen glass	9	2.2	
	A-pillar	1	0.2	
	Roof	26	6.3	8.7
Others		10	2.4	
N/A		17	4.1	6.5
Unknown		760	(not included)	
Total number of injuries		1176		

Table 5 provides a comparison of the number of vehicle damage records in the database for intrusion into the passenger compartment. It can be seen that the area between the A and B pillar was the most common area of intrusion, in particular at windscreen height. As there can only be one record for each of the 24 areas of intrusion on the vehicle, at least 47 of the 211 cases (nearly 25%) had intrusion at the windscreen level between the A and B pillar. Figure 2 explains the different possible intrusion zones within the vehicle.

Table 5. Zone and height level of intrusions into the vehicle compartment (also see Figure 2).

Zone	Height level	Number of intrusion records		
		Left	Right	Total
1 Foot well	Windscreen	6	6	12
	Dashboard	9	7	16
	Foot well	15	18	33
2 A- to B-pillar	Windscreen	47	42	89
	Dashboard	22	30	52
	Foot well	14	17	31
3 B- to C-pillar	Windscreen	18	25	43
	Dashboard	6	11	17
	Foot well	5	8	13
4 C-pillar to cell line	Windscreen	9	8	17
	Dashboard	2	2	4
	Foot well	1	1	2

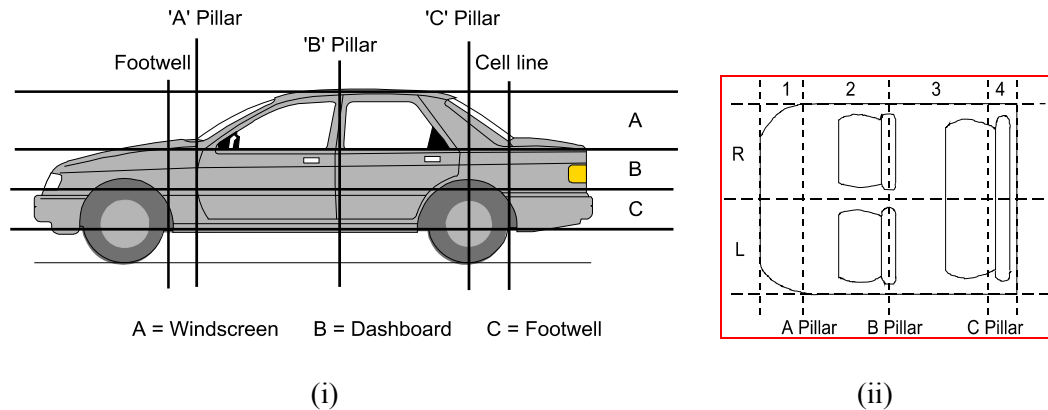

Figure 2. Diagrams highlighting the (i) vertical and (ii) lateral intrusion zones within the vehicle

The direction in which the vehicle ran off road is also worthy of consideration. In nearly two thirds of all cases, the vehicle initially left the road to the nearside. In the majority of cases (82%), the vehicle did not return to the road after its initial run-off (Table 6). However, in the majority of cases where the vehicle did manage to return to the road, the vehicle crossed over the road and had a subsequent encroachment in the opposing roadside (85% of all multiple run-offs). No vehicle had more than two run-offs.

Table 6. Location of encroachments for first and second run-offs

		2 nd run-off				Total
		Nearside	Offside	Central reserve	None	
1 st run-off	Nearside	3	17	5	111	136
	Offside	2	0	0	46	48
	Central reserve	8	0	2	17	27
Total		13	17	7	174	211

A new strength of the RISER detailed database was the ability to include information about the location of each impacted obstacle within the roadside and relative to the road.

The first approach involved locating each impacted obstacle within a pre-defined roadside zone. Figure 3 shows how these roadside zones can be determined (e.g. the A zone could be the hard shoulder, the B zone a grass embankment).

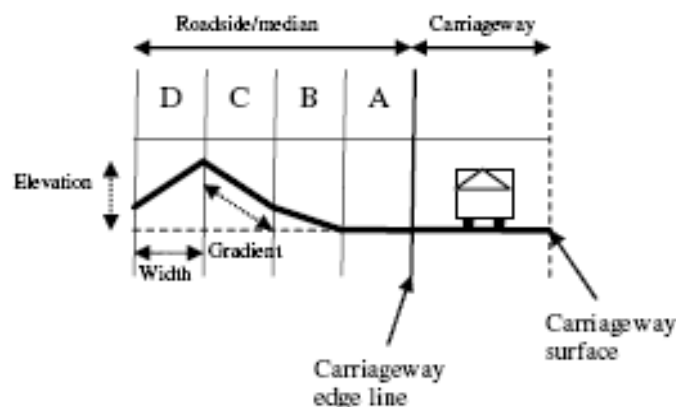

Figure 3. Schematic of the roadside/median zones

Table 7 summarises the type of objects impacted by the vehicles in the 211 accidents, the number of impacts recorded in the database (355 in total) and the roadside ‘zone’ where each obstacle was located. It shows that many rigid obstacles such as poles, posts and trees were located within the zone closest to the carriageway edge. 88% of the A zones measured in the database were less than 3m wide.

Table 7. The number of impacts that occurred in each roadside zone, for each type of struck infrastructure

Struck Infrastructure	Roadside zone (number of impacts in database)					Total
	A	B	C	D	Other*	
Safety barrier - steel	39	19	0	0	3	61
Safety barrier - concrete	4	0	0	0	1	5
Safety barrier - termination	2	9	0	0	2	13
Safety barrier - wire rope	0	0	0	0	1	1
Bridge parapet	1	3	0	0	0	4
Safety barrier - other	0	1	0	0	1	2
Arrester bed	0	0	0	0	0	0
Sign post	9	6	1	1	1	18
Lighting pole	6	9	2	1	0	18
Telegraph pole	4	1	2	1	3	11
Tree	2	14	25	5	4	50
Non-safety fence	1	2	2	1	4	10
Hedge	0	0	0	0	1	1
Wall	1	2	0	0	1	4
Bridge pier	2	1	4	0	1	8
Rock/boulder	0	2	9	5	2	18
Fog pole	2	0	0	0	0	2
Embankment/slope	3	14	24	15	10	66
Ditch	2	5	5	1	3	16
Drainage gully	0	2	0	0	2	4
Foot path	1	0	0	0	0	1
Cycle path	0	0	0	0	0	0
Pedestrian underpass	0	0	2	0	0	2
Other	7	10	6	2	15	40
Total number of impacts	86	98	82	32	55	355

* Other = Struck infrastructure which were located in more than one zone (e.g. AB, BCD)

Another interesting point to note about that data in Table 7 is that nearly 25% of all impacts were with a safety barrier. However, since there is a substantial coverage of safety barriers on the road network, it is not surprising that barriers are often struck in accidents. Narrow, often rigid objects such as poles, trees and posts made up 27% of the impacts, with terrain features such as embankments, ditches and gullies, and concrete or rock objects such as bridge piers, walls and boulders also making up a substantial amount of the impacts (24% and 8% respectively).

The second approach to evaluating obstacle location within the roadside involved measuring the set-back, which is the distance of the impacted objects from the carriageway edge. Figure 4 displays the minimum and maximum set-back for each type of impacted obstacle. It can be seen that many are set back less than 3m away from the roadside edge, in particular posts and poles. Many European countries set guidelines for roadside safety zones (area immediately beyond the road edge where no obstacles should be located) which can be as narrow as 4m in width [14]. So even at this minimal safety zone width, many of these obstacles would be located too close to the road edge.

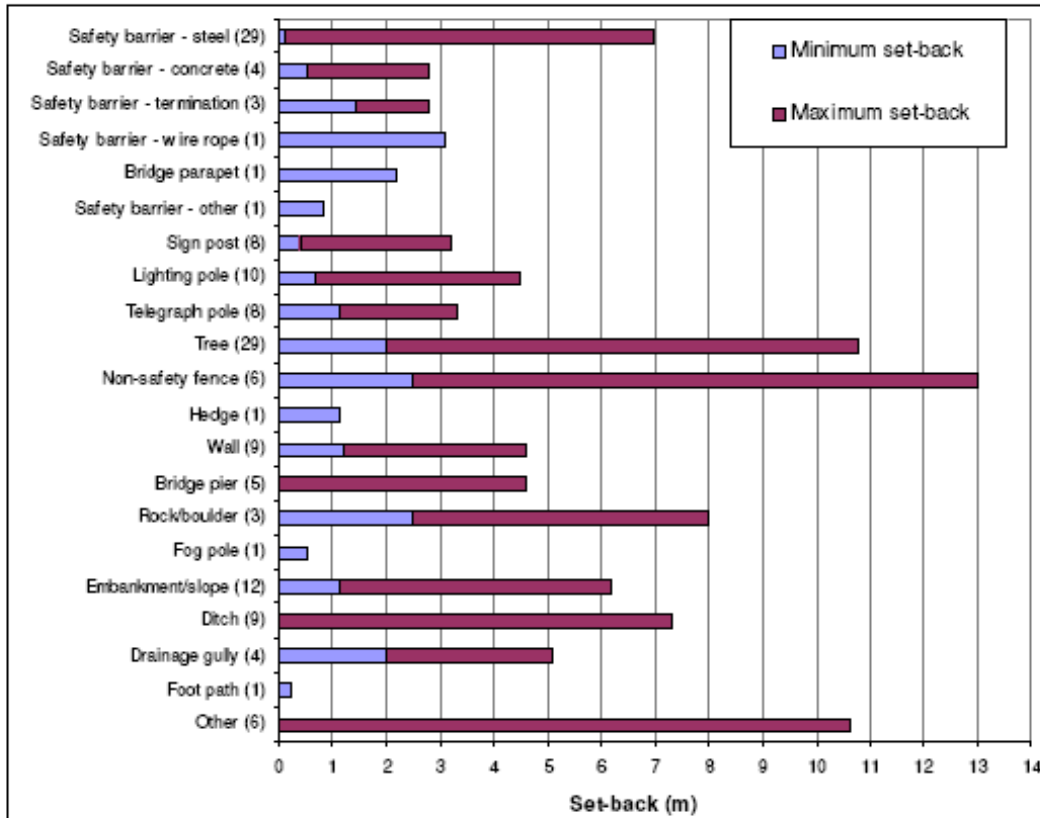

Figure 4. Minimum and maximum set-back distance for struck obstacles

The results of both the statistical and detailed database analysis have shown that roadside objects are often impacted in accidents, and impacts with rigid obstacles such as trees and poles are frequently fatal. Although impacts with safety barriers were also frequent, a greater proportion of these impacts led to less severe injuries, showing that impacts these structures lead to a great level of survivability than impacting other obstacles in the roadside.

In particular, injuries to the head and upper body appear to be prevalent, probably as a result of the vehicle occupants impacting structures between the A and B pillar. That is also the same area where the greatest level of intrusion occurred, and may therefore cause more severe injuries, especially if the intruding vehicle structure is supported by a rigid struck object.

It is not surprising to see how severe impacts with roadside obstacles can be when the data shows how close these obstacles can often be to the edge of the road (often less than 3m), and often without a suitable road-side recovery zone provided for drivers to take avoiding actions. Obstacles at such close proximity to the road edge will give the driver very little time to brake before an unavoidable impact, if in fact braking has an affect on the various types surfaces found on the side of the road (e.g. grass, gravel). This is an interesting point which should be investigated in future research.

Reconstruction data

The PC Crash Analysis tool was used in RISER to enhance the detailed accident information already collected at the scene and reconstruct further the impact conditions and vehicle dynamics at the point of collision. The main aim of reconstructing the RISER cases was to obtain road exit, impact and post-impact speeds and angles for vehicles. This data was then used to further analyse collisions with different types of objects, in particular rigid objects such as posts, poles and trees, and restraint

systems such as safety barriers. The results displayed in this section concentrate on just the speed data.

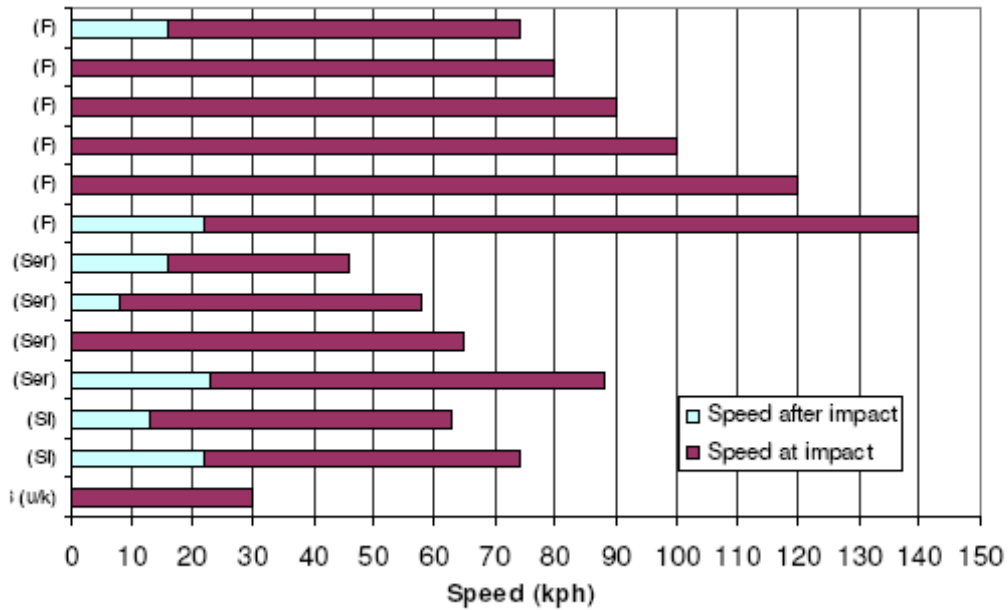

F = Fatal, Ser = Serious, Sl = Slight, u/k = Severity unknown
Figure 5. Speed at impact and after impact in tree collisions (n = 13)

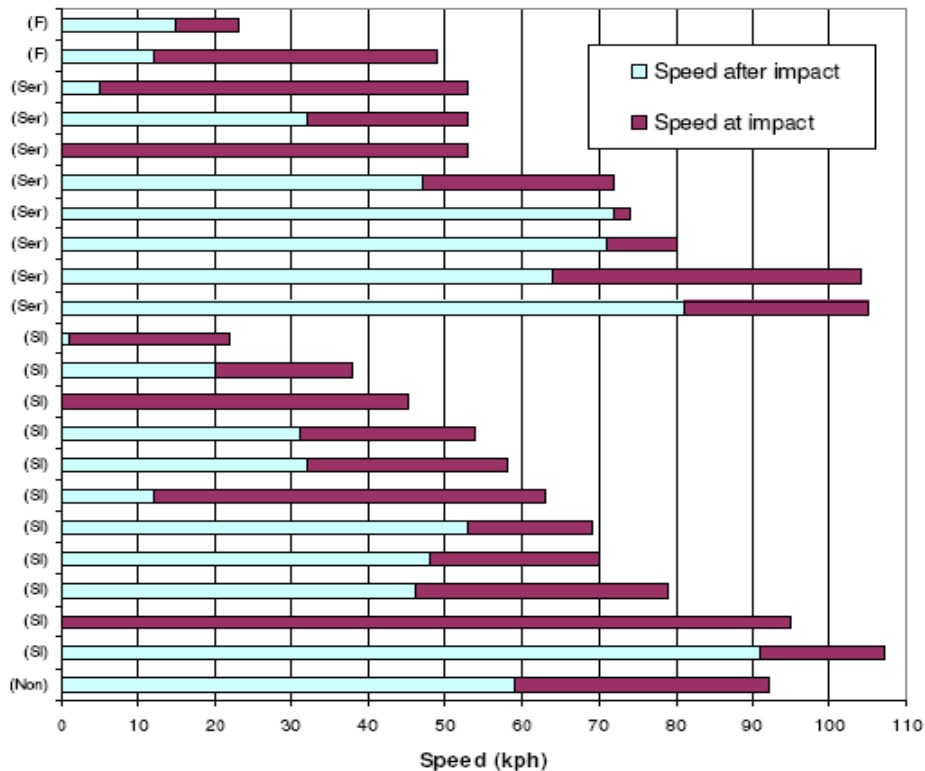

F = Fatal, Ser = Serious, Sl = Slight, Non = Non-injury
Figure 6. Speed at impact and after impact in safety barrier collisions (n = 22)

The speed at the point of impact does have an effect on the injury severity of the accident. Figure 5 shows the accident cases where both impact speed and post-impact speed were reconstructed for tree

impacts^h (13 from 38 ‘tree impact’ cases). The chart shows that in many cases, much of the vehicle's speed was lost during the impact with the tree. And in the fatal cases, the vehicle generally struck the tree at a greater speed, and therefore lost a greater amount of speed during impact.

In the detailed database, impact speeds and post-impact speeds were available for 22 of the 72 accidents involving a safety barrier impact. Figure 6 summarises this data.

Speed change (or delta V) at impact is known to have a strong, positive correlation with injury severity. Delta V is indicated by the dark red bars in Figures 5 and 6. Safety barriers are seen to perform as generally expected. That is to say, delta V values tend to be less than for trees, because vehicles are able to be contained by barriers without engagement of structures (which occurs with trees and other obstacles). In that way, high delta V and more serious injury outcomes are avoided.

However, in Figure 6, there is still less of a correlation between the change in speed (delta V) and the resulting injury severity than there is in Figure 5. A more in-depth investigation of all safety barrier accidents in the database show that after impact with the barrier, some vehicles rebounded back into the carriageway and impacted other obstacles (20 cases), leading to more severe injuries, whereas other vehicles were ‘contained’ by the barrier and came to rest alongside the barrier (14 cases). Proportionally, fatal cases were more prevalent in the sample of ‘rebound’ accidents (6 cases) than in the sample of ‘contained’ impacts (1 case). Objects impacted on the second run-off in the ‘rebound’ cases include a tree, pole, ditch and a wooden fence.

The reconstruction data has shown how important it is to ensure obstacles are not located too close to the road edge. Impacting a non-energy absorbing obstacle, such as a tree, can all too easily result in severe or fatal injuries, whereas impacting road restraint devices, such as safety barriers, can lead to a greater chance of survivability. The data from the tree accidents indicate that impact speeds above 70km/h can result in severe or fatal occupant injuries, whereas vehicle occupants have been shown to survive after impacting safety barriers at speeds above 90 km/h.

MADYMO simulation analysis

Figure 7 shows the relationship between Acceleration Severity Index (ASI) and the impact velocity. Higher impact velocities result in higher values for ASI. The Figure indicates that ASI values of above 1.4 occurred pre-dominantly for impact speeds above 20m/s (72 km/h). The trend shown between

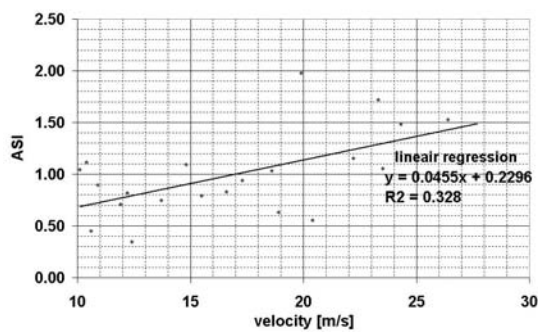

Figure 7. Relationship between Impact velocity and ASI

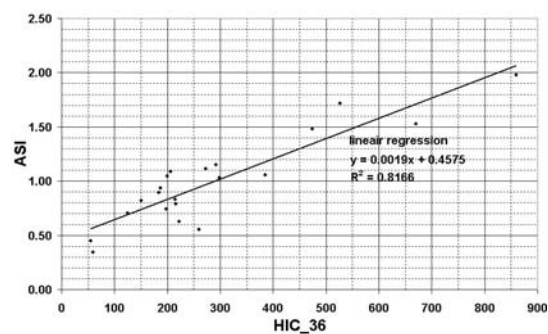

Figure 8. Linear correlation between HIC and ASI

^h All impacts were the first impact in the accident. This is the same for Figure 6.

velocity and ASI gives confidence in the model sensitivity to changes in velocity. The scatter in the 22 tests is partially caused by the fact that besides variations in impact velocity, the impact direction and orientation of the vehicle were also varied.

Head Injury Criterion (HIC) values were also calculated from the Hybrid III dummy model. A relationship between HIC and ASI exists as shown in Figure 8. Most of the test runs have ASI values below 2.00 and HIC values below the tolerance limit of 1000. The spread on the results is caused by the complexity of the three variables that are altered within this study; impact velocity, impact angle and vehicle orientation (refer to Table 1). The injury parameters taken into account in this study are HIC, VC (Viscous Injury Response) and chest deflection and also the vehicle based criteria ASI, THIV (Theoretical Head Impact Velocity) and PHD (Post-impact Head Deceleration). In Figure 7 and Figure 8 a correlation is indicated between the varied parameters (such as velocity) and the responses (such as HIC and ASI) can be observed. Similar correlations exist for other injury parameters and are reported elsewhere [9].

The simulation analysis showed that the MADYMO model of the safety barrier was found to replicate reasonably the barrier impact. The vehicle was successfully redirected. However, future work should be based on validating the response of the vehicle with respect to the barrier. Also the safety barrier model needs validation on component level in future studies.

The stochastic approach provided an insight into the system behaviour on a multi-parameter and multi-scenario level. Stochastic simulations allow for the variation of both environmental parameters, such as impact speed and angle, as well as structural parameters, such as barrier stiffness or vehicle mass. Generating a large sample of runs with multiple parameters does not result in perfect correlation due to a large spread of parameters in the stochastic models. However, it does result in trends between parameters, and further research would help to verify this.

The stochastic study also showed that the model response, in terms of ASI, is sensitive to changes in impact velocity, as is expected for the defined combination of ‘vehicle and safety barrier’. In addition, a relationship between ASI and HIC is shown for the simulated scenarios of impact speeds ranging from 35 to 100km/h at impact angles between 5° and 35°. The result indicates that ASI is a reasonable predictor of crash severity in safety barrier impacts. Extensive model validation is a pre-requisite for an absolute qualification of a safety barrier system, although a non-validated but realistic model would provide a useful insight in trend and sensitivity studies.

The information from the MADYMO analysis could be linked with the in depth database results. The injury levels are known in the database as well as in the simulation results. The next step would be to determine speeds for vehicle run-offs. If this is known, it would be possible to choose the most appropriate safety barrier to lower the injury levels when another accident occurs under the same conditions. A closer examination of all parameters derived from real-world accident data, including injury outcomes at various body regions, could usefully follow for further assessment of both safety barrier performance and any beneficial development of the test procedures that may be possible.

Crash Test Data

After the decision to consider only the data concerning the different types of safety barriers, it was found there were 97 crash tests available for use from countries across Europe (e.g. Austria, Finland, Germany, Sweden, The Netherlands). From these tests, it was possible to undertake comparisons of permanent deflection of the safety barriers with the ASI values in 68 crash tests, while comparisons of the permanent deflection value with the THIV was possible in 47 tests. Five types of crash tests criteria as described in EN1317-2 [15] were available in this sample, the details of which are displayed in Table 8.

Table 8. Vehicle impact test criteria (taken from EN1317-2) [15]

Test	Impact speed km/h	Impact angle degrees	Total vehicle mass kg	Type of vehicle
TB11	100	20	900	Car
TB21	80	8	1 300	Car
TB31	80	20	1 500	Car
TB32	110	20	1 500	Car
TB42	70	15	10 000	Rigid HGV

When the ASI and THIV data are plotted on charts, the data appears to be widespread for comparisons of permanent deflection of the safety barrier with both ASI and THIV measurements. However, when each crash test group is highlighted, as shown in Figure 9 for ASI/permanent deflection comparisons, it can be seen that each group has its own cluster on the chart. The chart also confirms that a crash test group with a low impact angle and speed, such as TB21, has proportionally lower values in the chart, indicating better safety performance, compared to a group with a greater impact angle and speed, such as TB11.

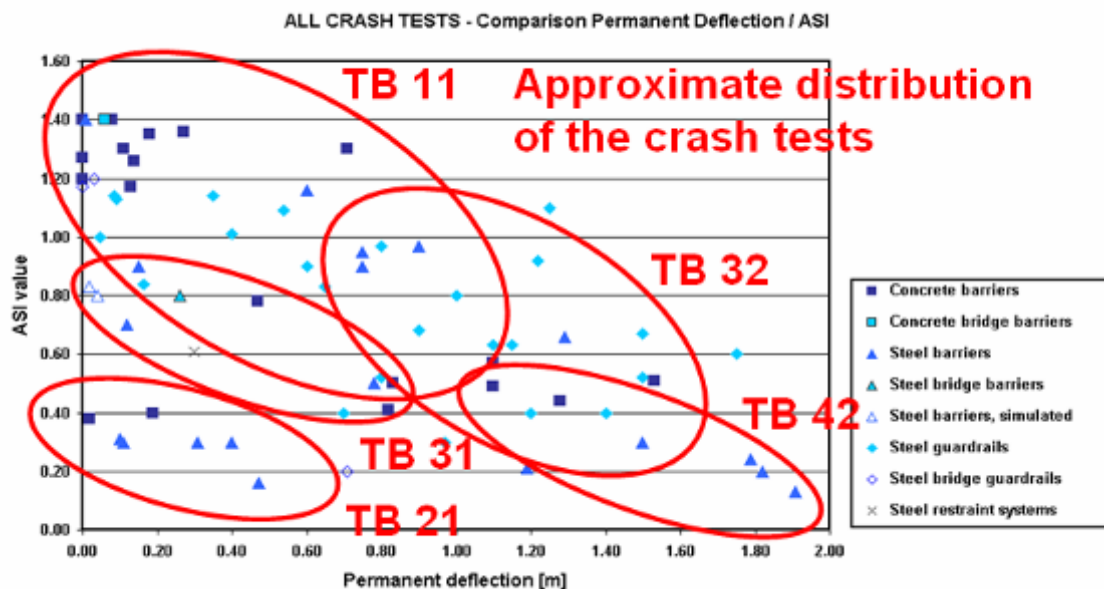

Figure 9. Approximate distribution of the crash tests

Another interesting observation to make is that in each of the cluster groups, there is a trend where the greater the permanent deflection, the lower the ASI value. Although the results are not shown, this trend also occurs with THIV.

A full comparison between different types of safety barriers was not possible, due to the variation in test performances (e.g. availability of certain test data variables) and sometimes the test requirements between the crash tests in the sample. However, the collected data could potentially be used for developing guidelines if compared with deflection and injury values from real-world accident data.

CONCLUSIONS

The results have shown that impacts with rigid objects such as trees can often lead to severe injuries, and such impacts are seen to occur frequently with such objects located close to the road edge, often as little as just two meters from the edge. Vehicle restraint systems, such as safety barriers have shown

to help protect vehicle occupants from these types of dangerous obstacles, which can be seen from both the accident data and the reconstruction data. Injuries resulting from contact of the occupant with the side of the vehicle interior, commonly involving an intruding structure, have been shown to be of concern.

Ideally, non-crash-energy absorbing obstacles, such as trees and rigid posts, should be removed or relocated as far away as possible from the road edge to ensure drivers have as much room as possible for deceleration before impact. However, when this is not possible, installation of safety barriers to protect vehicles from the obstacles is a safe alternative.

It is therefore important that the correct type of safety barrier for the type of roadway is used to ensure maximum protection for occupants. For example, the data shows that it is a safety advantage for vehicles to be contained in the roadside by the barrier and not to be rebounded back into the carriageway where further, potentially more severe impacts could occur, often in the opposing roadside.

Understanding the performance of safety barriers during impact can be enhanced by using simulation software and undertaking crash tests. In addition, this work shows the value and importance of in-depth, real-world accident data as an essential basis for the definition of simulation parameters and subsequent validations. The authors believe that there is much future scope for a more extensive synthesis of the unique combination of resources established for the RISER project, including accident data with detailed mathematical reconstructions, crash test data and numerical simulations. This will enable further study to be undertaken on the proposed modifications to the different types of infrastructure, including their influences on the levels of impact severity. It will also make it more feasible to study not only collisions with both rigid and flexible collisions and from this, develop new deformation zones in vehicles.

This paper set out to illustrate the range of data sources collected together for the RISER project. It has been seen that real-world data is invaluable for the assessment of accident conditions. The RISER databases have successfully brought together descriptive and in-depth data which have proved valuable and complimentary for accident analysis. In addition, existing crash test data has been gathered into a new and unique data resource, and when synthesized together with the accident data proved most effective as a basis for appraising the performance of road-side infrastructure and for making design recommendations [16].

ACKNOWLEDGMENT

RISER is a project co-funded by the European Commission under the Competitive and Sustainable Growth Programme. The RISER Consortium are Chalmers University of Technology, Gothenburg, Sweden; Vehicle Safety Research Centre, Loughborough, United Kingdom; Graz University of Technology, Graz, Austria; Centre D'etudes Techniques de L'Equipement Normandie-Centre, France; European Road Federation; Fundación para la Investigación y Desarrollo en Automoción (CIDAUT), Valladolid, Spain; Hierros Y Aplanaciones, S.A., Asturias, Spain; Helsinki University of Technology, Helsinki, Finland; TNO Automotive, Delft, the Netherlands; TNO Human Factors, the Netherlands; Volkmann & Roszbach, Montabaur, Germany. The views expressed in this paper belong to the authors and are not necessarily those of the European Commission or the RISER Consortium.

Further information may be found on the RISER project website:
www.erf.be/section/ep/riser

REFERENCES

1. AA Motoring Trust, EuroRAP 2005, British Results, Tracking collisions and road improvements, Monitoring motorcycle involvement, Benchmarking across Europe, March 2005
2. Collin, C. Statistics in Focus – Transport, Eurostat catalogue number CA-NZ-00-003-EN-I, 2000
3. European Transport Safety Council (ETSC), Forgiving Roadsides - Research Paper prepared for the ETSC Road Infrastructure Working Party, Brussels, 1998
4. Great Britain Study Proctor, S., Single Vehicle Loss of Control Collisions and Passive Safety, Traffic Signs, Signals, and Lighting, the Passive Revolution Conference, Institution of Civil Engineers, London, 22 June 2005
5. Reagan. J.A., The Highway Perspective of Side Impacts, Society for Automotive Engineers International Congress and Exposition, Detroit, Michigan, USA, March 1-5, 1993
6. Roads and Traffic Department New South Wales, Fatal Roadside Object Study, Road Environment Safety Update 20, Australia, 9 March 2003
7. Insurance Institute for Highway Safety USA, Fatality Facts 2003: Roadside Hazards, www.iihs.org/safety_facts/fatality_facts/roadside_hazards.htm
8. D01: Accident Databases for Collisions with Roadside Infrastructure, European Community R&TD Project, 5th Framework Programme “Growth”, Project "RISER" GRD2/2001/50088, 2003
9. D03: Critical Vehicle and Infrastructure Interactions, European Community R&TD Project, 5th Framework Programme “Growth”, Project "RISER" GRD2/2001/50088, 2006
10. ADVISER USER'S Guide; Version V1.4, MECALOG Business unit Safety; May 2004
11. ADVISER Reference Guide; Version V1.4, MECALOG Business unit Safety; May 2004
12. EN 1317-1. Road Restraint Systems – Part 1: Terminology and general criteria for test methods. . CEN – European Committee for Standardisation, Central Secretariat: rue de Stassart 36, B-1050 Brussels, © 1998
13. Association for the Advancement of Medicine. P.O. Box 4176 Barrington, IL 60011-4176. Abbreviated Injury Scale (AIS) 1998
14. D05: Summary Of European Design Guidelines For Roadside Infrastructure, European Community R&TD Project, 5th Framework Programme “Growth”, Project "RISER" GRD2/2001/50088, 2003
15. EN 1317-2. Road Restraint Systems – Part 2: Performance classes, impact test acceptance criteria and test methods for safety barriers. CEN – European Committee for Standardisation, Central Secretariat: rue de Stassart 36, B-1050 Brussels, © 1998
16. D06: European Best Practice for Roadside Design: Guidelines for Roadside Infrastructure on New and Existing Roads, European Community R&TD Project, 5th Framework Programme “Growth”, Project "RISER" GRD2/2001/50088, 2006